

# NEFELE

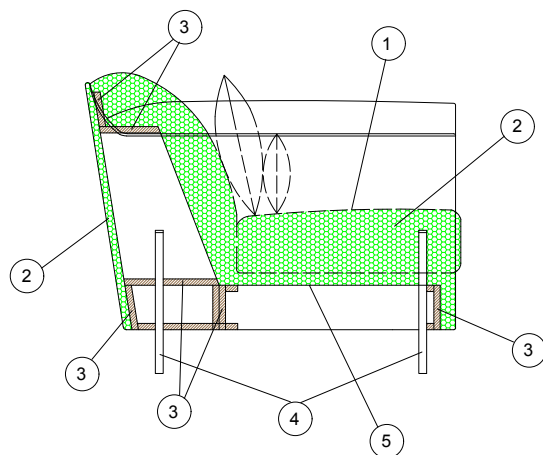

- 1 - fibra di dacron® 100 gr;
- 2 - poliuretano espanso indeformabile di diverse densità;
- 3 - telaio in multistrato di abete;
- 4 - piedi in metallo verniciato ottone lucido/  
piedi in legno wengè;
- 5 - cinghie elastiche intrecciate.



## DIMENSIONI

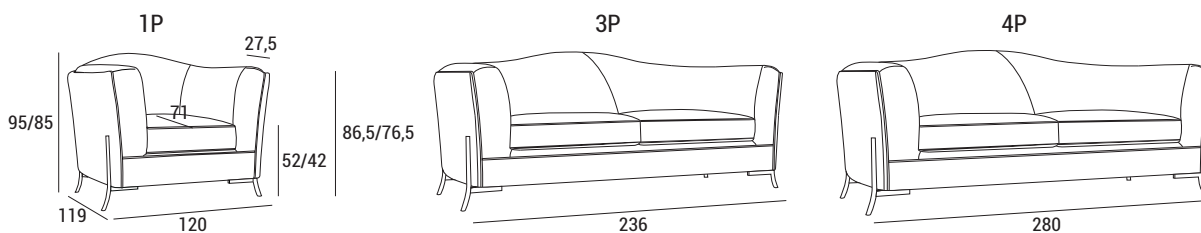

## LAVORAZIONE SCOCCA ESTERNA



## LAVORAZIONE SCHIENALE INTERNO



# NEFELE

## VERSIONI

**Basic**  
Senza  
cuscini

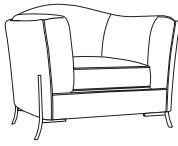

**Luxury**  
Include cuscini  
monocromatici rivestiti  
con medesimo tessuto/  
pelle e variante del  
divano

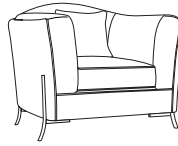

**Decor**  
Come foto  
catalogo

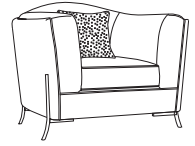

Cuscini inclusi in versione Luxury e Decor

1P 1S **1** 45x45

4P 4S **6** 35x25 **6** 45x45

3P 3S **4** 35x25 **5** 45x45

## PIEDI

P 64 h 14



P 59 h 4,5



## LETTO

3P Kg 46

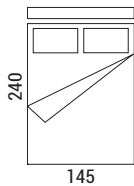

Con piede P 64

3P Kg 35

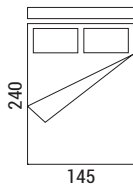

Con piede P 59

4P Kg 52

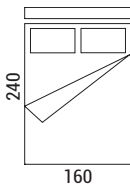

Con piede P 64

4P Kg 37

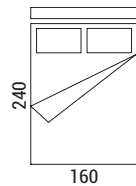

Con piede P 59

Materasso in poliuretano espanso  
a due pieghe, normale o ignifugo,  
h 12 cm, rivestito con tessuto  
anallergico.  
Rete elettrosaldata di acciaio  
ad alta resistenza.

## MECCANISMO LETTO

### Apertura

1

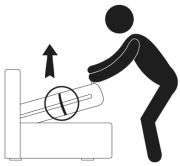

2



3

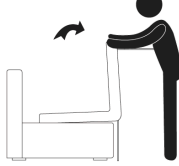

**RIMUOVERE**  
le fascette ai lati prima  
di sollevare la rete

Un'errata apertura del letto  
può provocare  
la rottura del meccanismo

### Chiusura

1

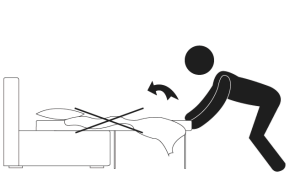

2

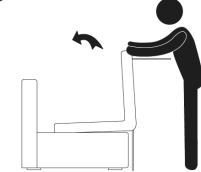

3



**RIMUOVERE**  
lenzuola, coperte o cuscini prima  
della chiusura del letto per evitare  
danni al meccanismo

## INFORMAZIONI TECNICHE

Sfoderabile: NO

	kg	m <sup>3</sup>	mts
NEFELE 1P P 64/P 59	51/49	1.35	9.00 basic capitonné - 8.50 basic plain 9.50 luxury capitonné - 9.00 luxury plain
NEFELE 3P P 64/P 59	70/68	2.67	16.00 basic capitonné - 15.00 basic plain 20.00 luxury capitonné - 19.00 luxury plain
NEFELE 4P P 64/P 59	98/96	3.16	17.50 basic capitonné - 16.50 basic plain 22.50 luxury capitonné - 21.50 luxury plain
CUSCINO LUXURY 45X45	/	0.03	0.50
CUSCINO LUXURY 35X25	/	0.02	0.30
CUSCINO DECOR 45X45	/	0.03	0.75
CUSCINO DECOR 35X25	/	0.02	0.50

## PHOTO GALLERY



Nefele 1P in versione capitonnè nella scocca esterna e fascia frontale e liscia nello schienale interno



Nefele divano 3 posti in versione capitonnè nella scocca esterna e fascia frontale e liscio nello schienale interno



Nefele divano 4 posti in versione liscia nella scocca esterna e fascia frontale e capitonnè nello schienale interno

