

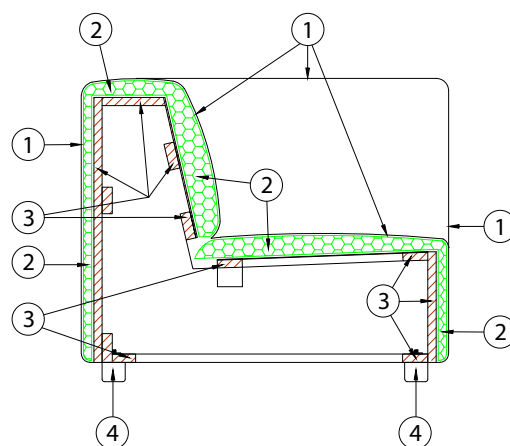

Pan è una collezione modulare di cubi e parallelepipedi all'interno dei quali sono scavate ampie sedute. Gli elementi della collezione possono essere liberamente combinati tra loro seguendo le forme geometriche, e corredati di pouf giganti di diverse altezze, così da creare giochi volumetrici irregolari. Linearità e spigoli netti caratterizzano Pan, collezione imponente e monolitica.

- 1 - fibra di dacron® 100 gr;
- 2 - poliuretano espanso indeformabile di diverse densità;
- 3 - telaio in multistrato di legno di abete;
- 4 - piedi in PVC.



DIMENSIONI:

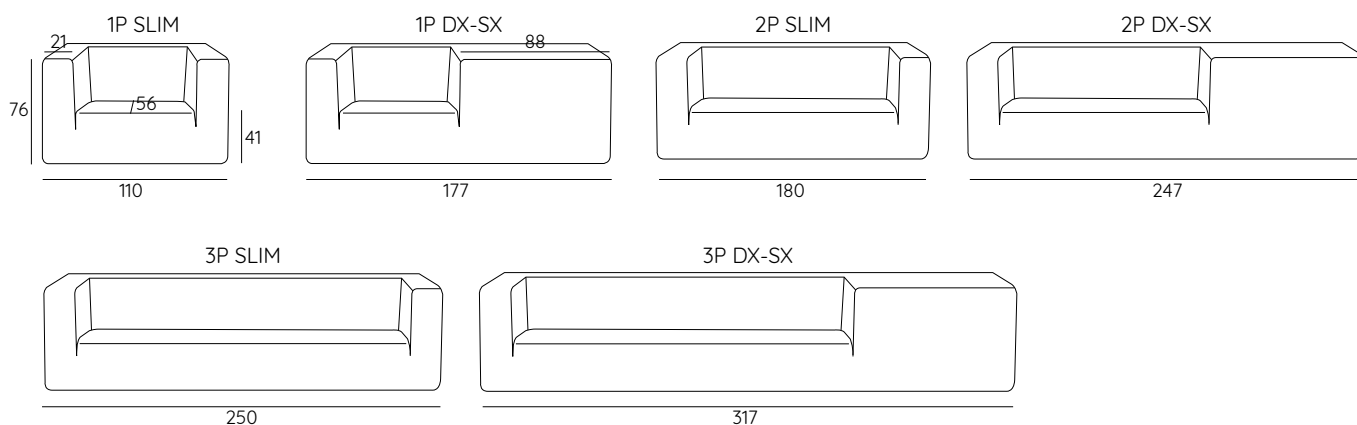

Pouf

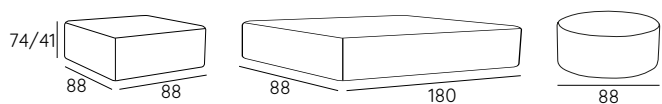

COMBINAZIONI SUGGERITE:

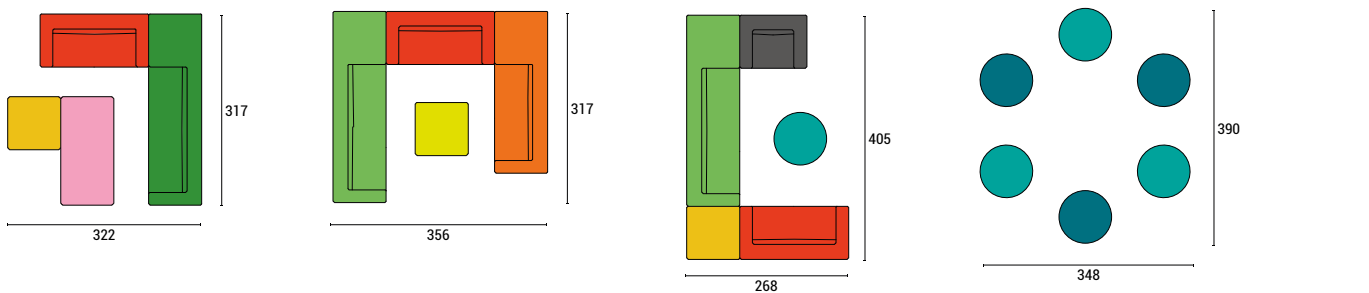
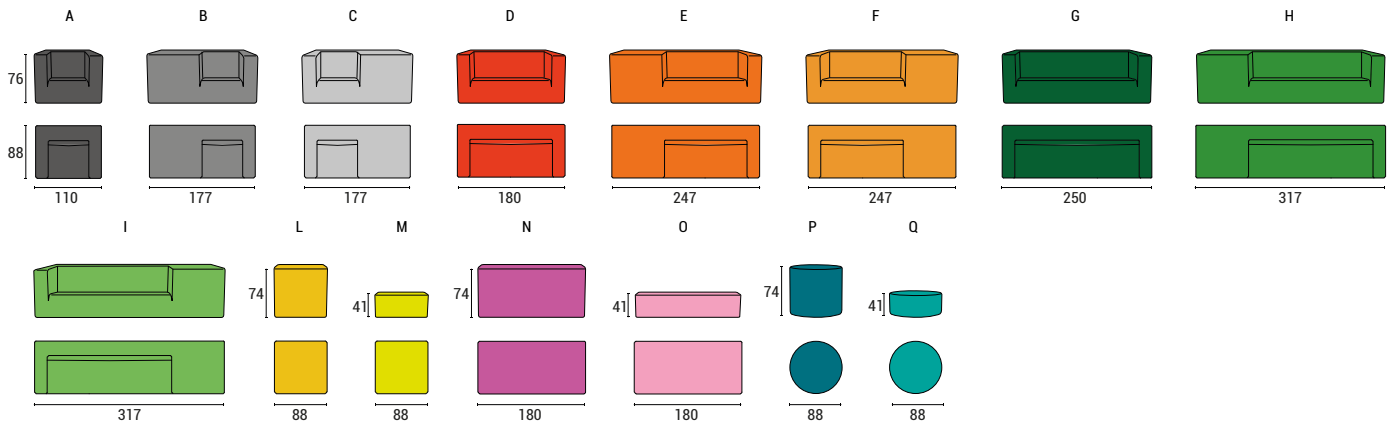

A 1XD 1XL
1XH 1XO

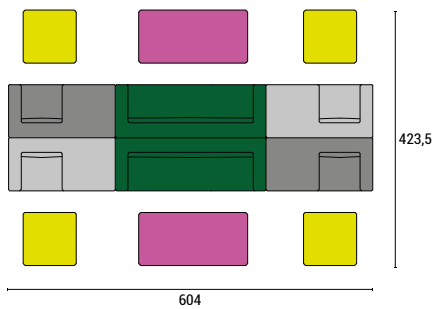

B 1XD 1XI
1XE 1XM

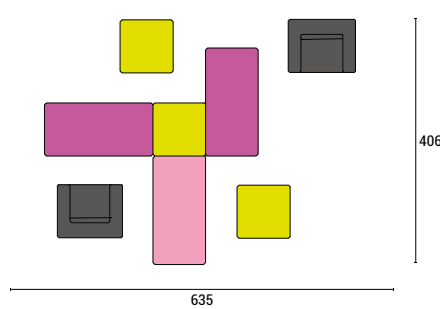

C 1XA 1XL
1XD 1XQ
1XI

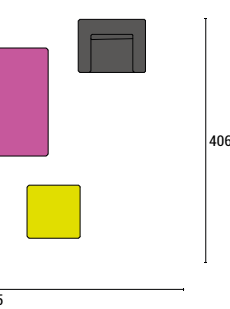

D 3XP
3XQ

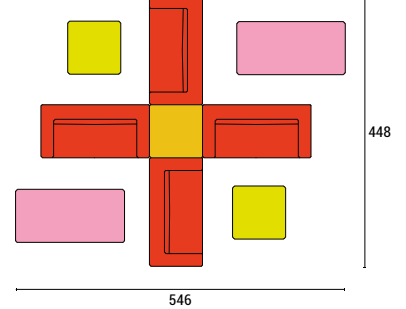

D 2XB 4XM
2XC 2XN
2XG

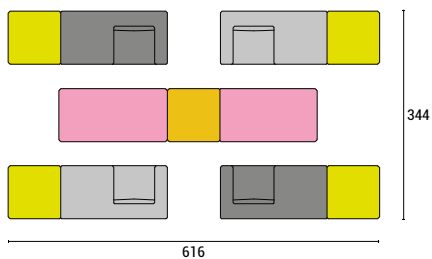

E 2XA 1XO
3XM

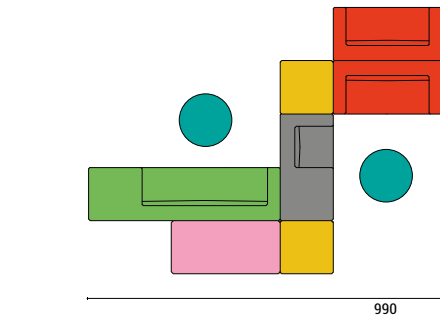

F 4XD 2XM
1XL 2XO

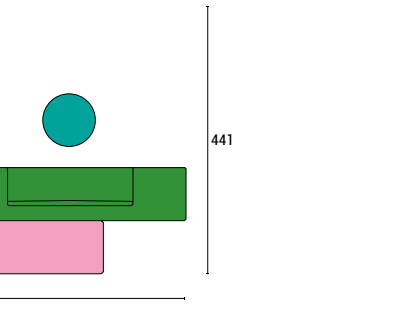

G 2XB 4XM
2XC 2XO
1XL

H 1XB 1XH 2XO
1XC 1XI 3XQ
2XD 4XL

PIEDI:

h2

**INFORMAZIONI TECNICHE:**

Sfoderabile: NO	kg	m ³	mts		kg	m ³	mts
PAN SLIM 1P	36	0.73	4.00	POUF LOW 88x88	14	0.32	2.70
PAN 1P DX-SX	46	1.18	6.00	POUF LOW 180x88	27	0.65	5.30
				POUF LOW Ø88	12	0.32	2.60
PAN SLIM 2P	50	1.20	5.80				
PAN 2P DX-SX	60	1.65	8.50	POUF HIGH 88x88	25	0.57	4.70
				POUF HIGH 180x88	48	1.17	7.20
PAN SLIM 3P	72	1.67	8.20	POUF HIGH Ø88	20	0.57	3.10
PAN 3P DX-SX	82	2.12	9.50				

RIVESTIMENTI CONSIGLIATI: