

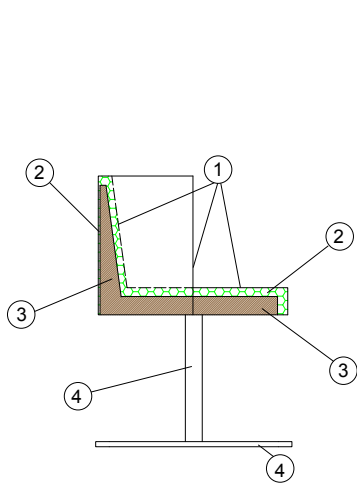

Tigram: l'arte di giocare con le forme geometriche e trasformarle in divani e poltrone.

Partendo dal concetto del Tangram, antico gioco cinese basato sulla componibilità di 7 forme geometriche con le quali si possono costruire infiniti disegni e figure, Tigram si sviluppa sulla base di forme geometriche semplici, su elementi primari componibili che le permettono di trasformarsi in un insieme complesso di figure liberamente interpretabili sia per chi le progetta, sia per chi le osserva. 7 elementi tra poltrone, divani, pouf e sgabelli, tutti rigorosamente modellati su una base esagonale, con diverse dimensioni ed altezze, disponibili in un'ampia varietà di colori, si uniscono e si separano creando figure e simboli e cromie mutanti come in un caleidoscopio. È una collezione perfetta per arredare locali pubblici che hanno la necessità di arredi flessibili e modulari, facilmente adattabili ai diversi momenti di vita dei luoghi vissuti da collettività in movimento, che mutano continuamente l'ambiente in cui si spostano. Tigram non è solo un insieme articolato, ma anche un singolo pezzo scelto ad hoc per un corner sofisticato o un angolo chiacchiere esclusivo di un ambiente domestico frutto di ricerca e studio, nel quale Tigram si inserisce nella versione con schienale basso, nel ruolo di divanetto discreto o di trono altezzoso.



TIGRAM CHAIR:

- 1 - fibra di dacron® 100 gr;
- 2 - poliuretano espanso indeformabile di diverse densità;
- 3 - telaio in multistrato di legno;
- 4 - base girevole in inox lucido e colonna in metallo cromato.

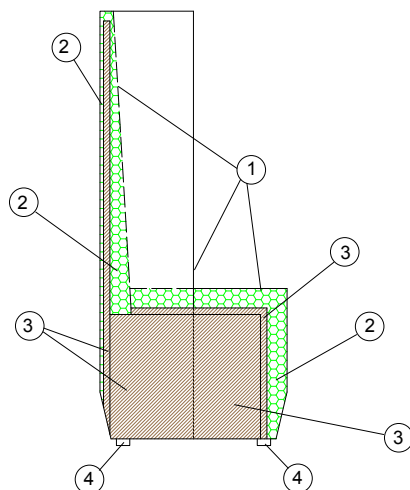

TIGRAM LOW-HIGH:

- 1 - fibra di dacron® 100 gr;
- 2 - poliuretano espanso indeformabile di diverse densità;
- 3 - telaio in multistrato di legno;
- 4 - piedi in PVC.

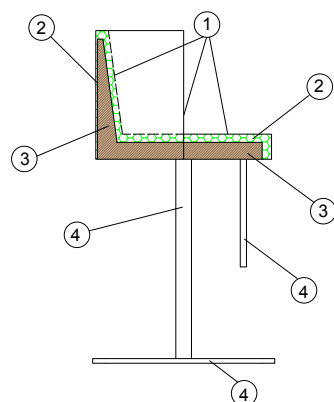

TIGRAM STOOL:

- 1 - fibra di dacron® 100 gr;
- 2 - poliuretano espanso indeformabile di diverse densità;
- 3 - telaio in multistrato di legno;
- 4 - base girevole in inox lucido e colonna in metallo cromato.

DIMENSIONI:

Low

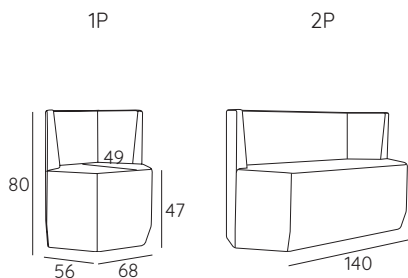

High

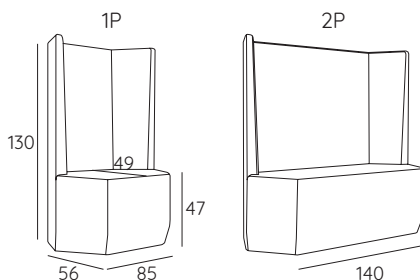

Chair

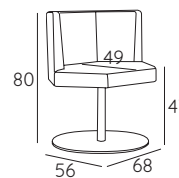

Stool

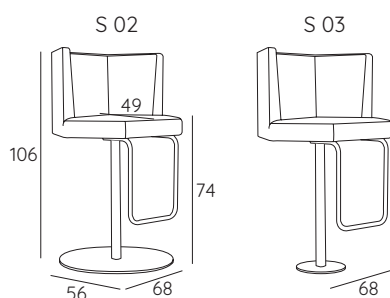

Pouf

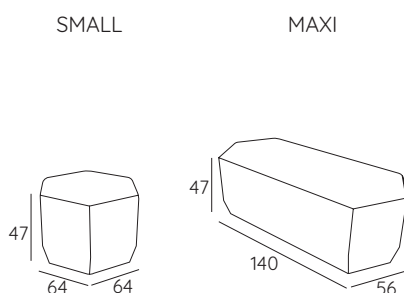

PIEDIE BASI:

Low e High



Chair



Stool



Pouf



FINITURE METALLO BASI:

DI SERIE

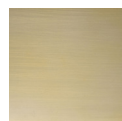
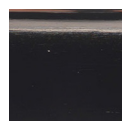
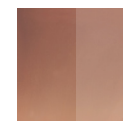
cromo
satinato/lucidoottone
lucidoottone brunito
satinatocanna di
fucile lucidooro
opaco/lucidobronzo ottone
semilucidobronzo rame
semilucidorame
opaco/lucido

OPTIONAL

RAL su
richiesta

INFORMAZIONI TECNICHE:

| Sfoderabile: NO | kg | m ³ | mts | | kg | m ³ | mts |
|-----------------|----|----------------|------|-------------------|----|----------------|------|
| TIGRAM LOW 1P | 20 | 0.30 | 2.80 | TIGRAM STOOL S 02 | 32 | 0.40 | 2.80 |
| TIGRAM LOW 2P | 39 | 0.63 | 4.00 | TIGRAM STOOL S 03 | 25 | 0.40 | 2.80 |
| TIGRAM HIGH 1P | 34 | 0.62 | 3.80 | TIGRAM POUF SMALL | 13 | 0.19 | 1.20 |
| TIGRAM HIGH 2P | 48 | 1.02 | 5.00 | TIGRAM POUF MAXI | 30 | 0.37 | 2.80 |
| TIGRAM CHAIR | 24 | 0.30 | 2.80 | | | | |

COMBINAZIONI SUGGERITE:

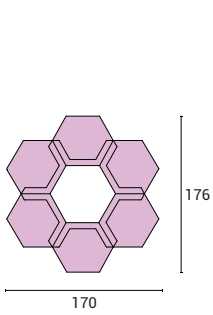
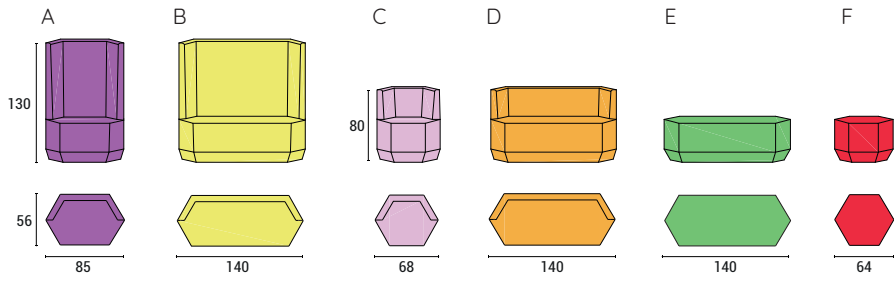

A 6XC

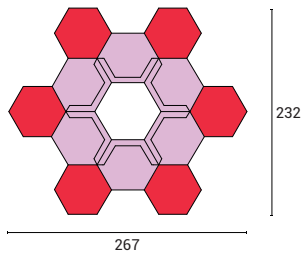

B 6XC
6XF

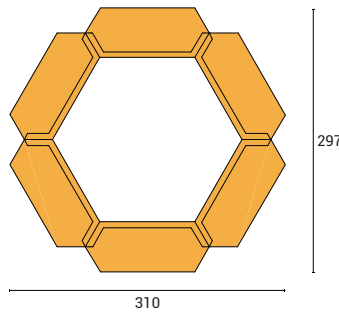

C 6XD

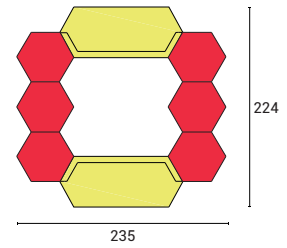

D 2XB
6XF

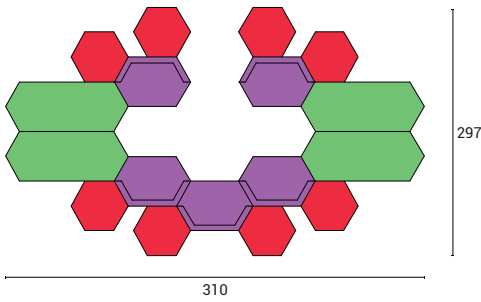

E 5XA
4XE
8XF

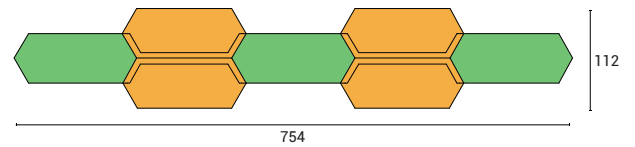

F 4XD
3XE

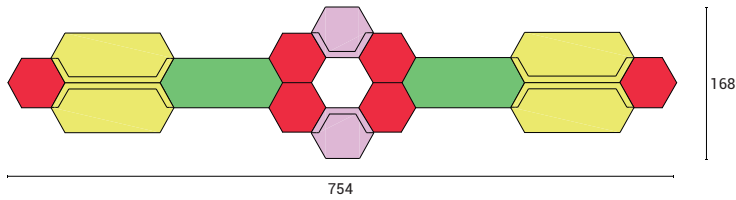

G 4XB 2XE
2XC 6XF

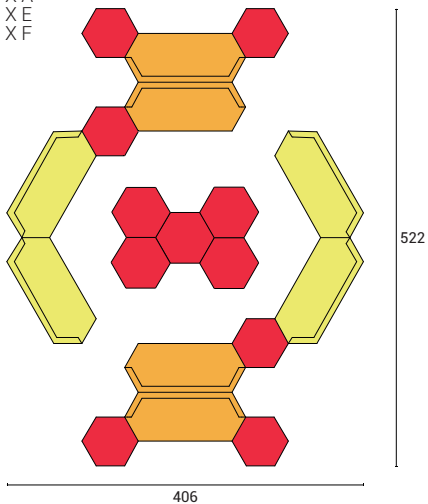

H 4XB 1XE
4XD 11XF

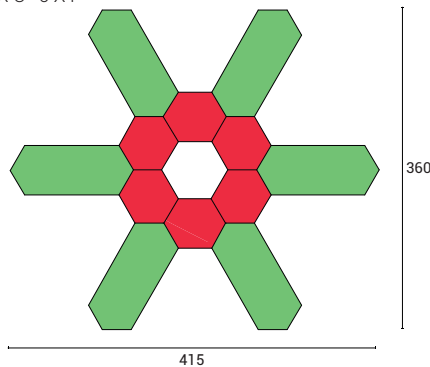

I 6XE
6XF

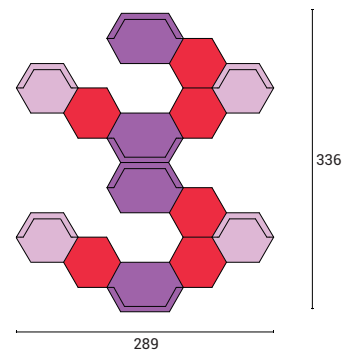

L 4XA
4XC
6XF

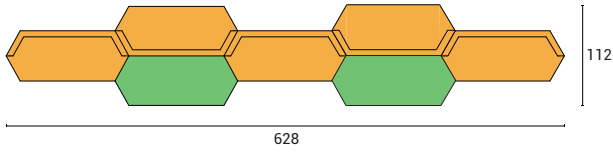

M 5XD
2XE

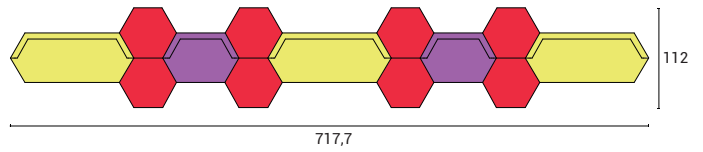

N 2XA
3XB
8XF

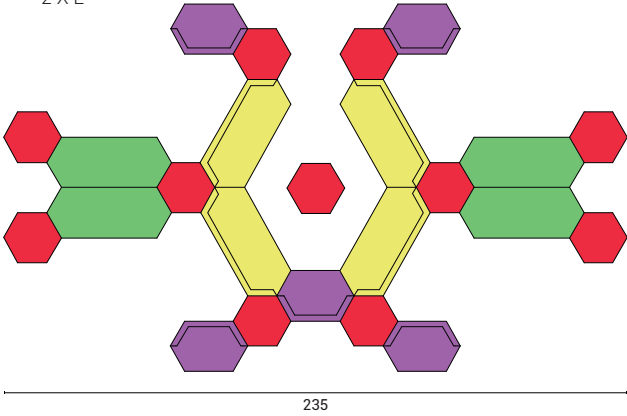

O 5XA 4XE
4XB 11XF

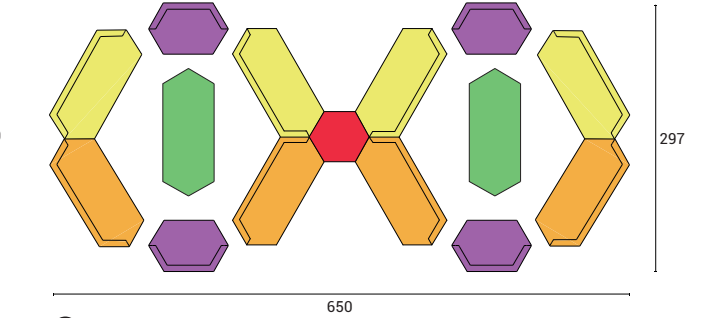

P 4XA 2XE
4XB 1XF
4XD

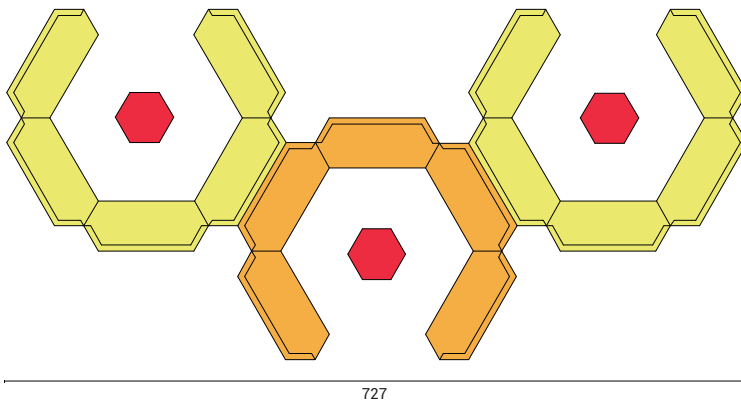

Q 10XB
5XD
3XF

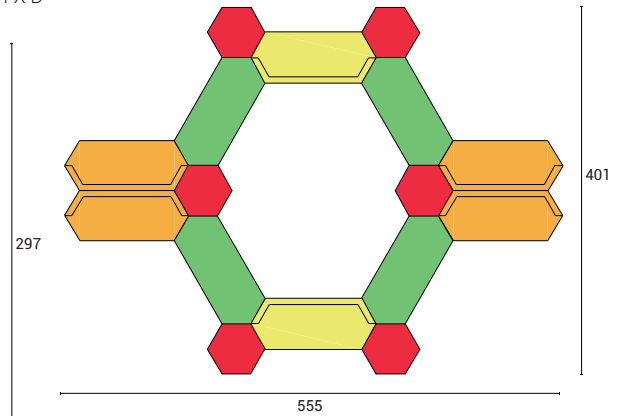

R 12XB
6XD
3XF

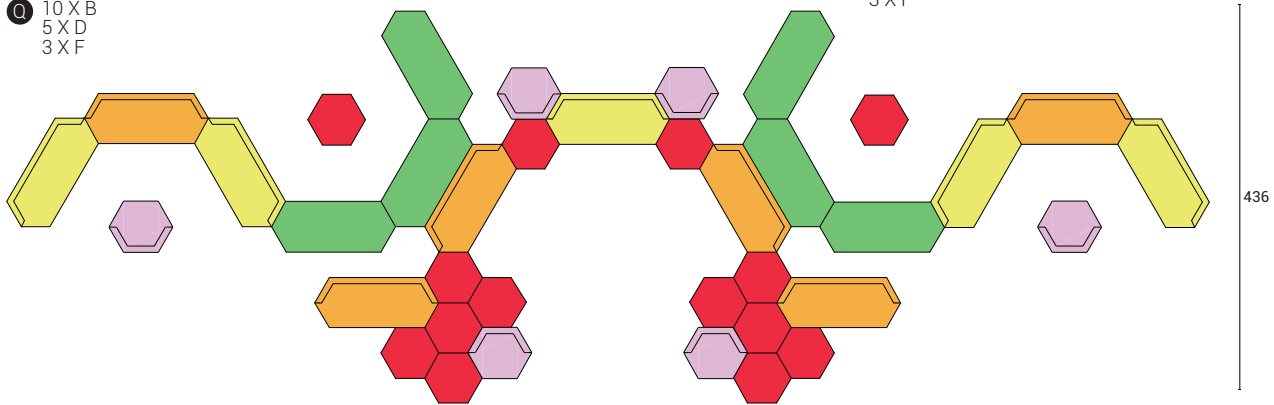

S 5XB 6XE
6XC 14XF
6XD

RIVESTIMENTI CONSIGLIATI:

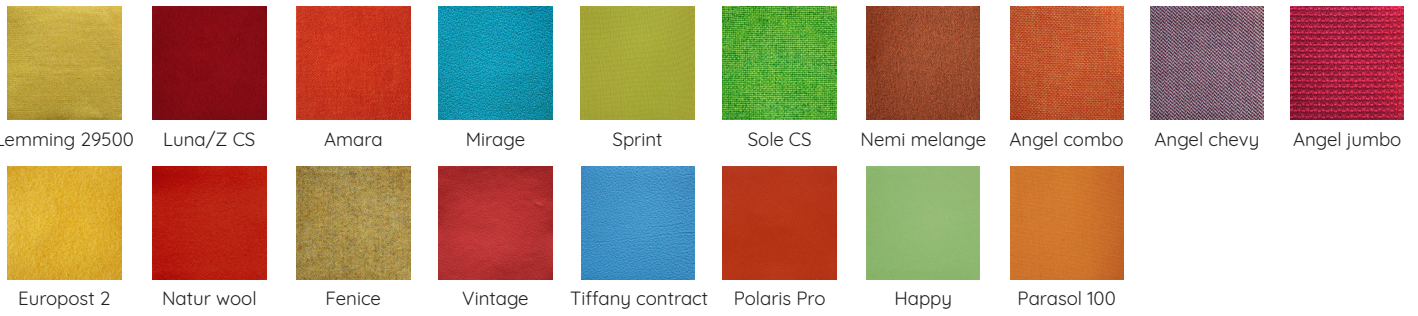

PHOTO GALLERY:



Tigram low poltrona



Tigram low divano



Tigram high poltrona



Tigram high divano



Tigram chair



Tigram pouf small e maxi